

Programmierung

Verbindungen zum Programmiermodul
Nur erforderlich, wenn der MC neu programmiert werden soll.

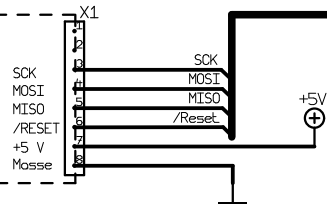

DCF-Signal

DCF-Empfänger (z. B. Conrad)

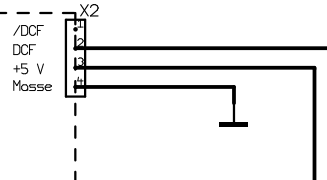

Stromversorgung

AKKU

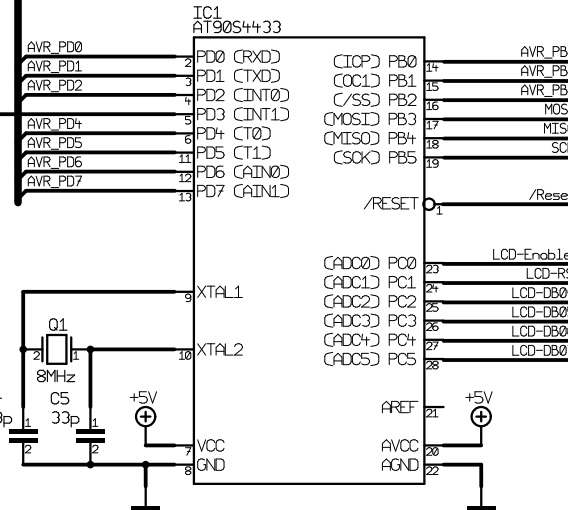
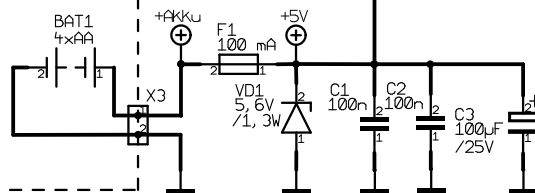

LCD-Hintergrund-Beleuchtung

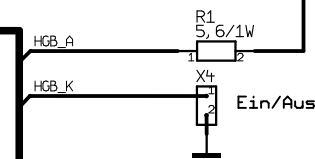

LCD-Anzeige

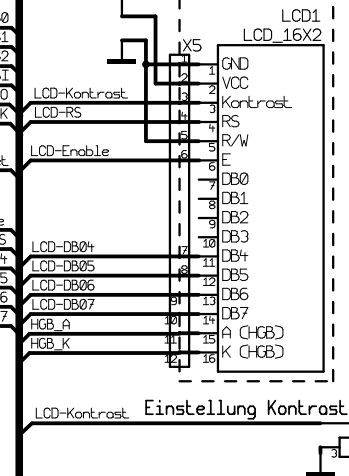

I/O-Port

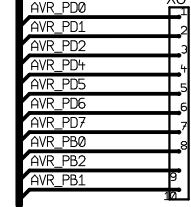

Maßstab	Datei 01_FUM_CSP_UND_LP_T2001	Zeichner Bauer	Blatt 1 von 1
Version	010504	Titel Funkuhrmodul FUM	
Ausgabe	28.08.04		
Entwickler	Amatronik	Projekt DCF-Empfänger	